

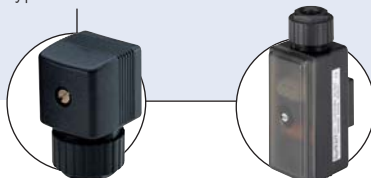

Typ 6027 Klein kombinierbar mit



**Type 2508**  
Cable plug

**Type 1078**  
Timer unit

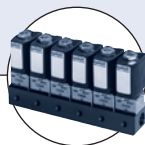

**Type 6027**  
Multiple manifold (e.g. 6-fold)



**Type 2511**  
ASI cable plug

## 2/2-way Small Solenoid Valve, G 1/8 - G 3/8 and sub-base

- Direct-acting, normally closed and normally open
- Brass and stainless steel body
- High temperature version up to +180°C
- Optimised coil combination for standard pressure ratings
- Also available as impulse version

Type 6027 is a direct-acting solenoid valve used for shut-off, dosing, filling, ventilating and for vacuum. The push-over solenoid system is of modular design and may be mounted individually or as a block on a multiple manifold. The coil can be rotated 360°.

For use as impulse version please see instructions on p. 5.

### Circuit function A

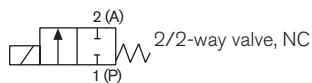

### Circuit function B

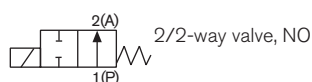

Technical data	
<b>Port connection</b>	G 1/8, G 1/4, G 3/8, sub-base (NPT and Rc on request)
<b>Orifice</b>	DN 2.0 - 6.0
<b>Body materials</b>	Brass or stainless steel 1.4404 (316L)
<b>Coil materials</b>	Epoxy and polyamide
<b>Coil insulation class</b>	Epoxy class H, polyamide class B
<b>Seal material</b>	FKM, PTFE/graphite for high temperature versions
<b>Media</b>	Vacuum, neutral gases and liquids (e.g. compressed air, town gas, natural gas, water, hydraulic oil, petrol) and slightly aggressive media (stainless steel version) Hot fluids and steam
<b>Media temperature</b>	High temperature version FKM, epoxy coil: -10 to +120°C (circuit function B, AC power supply: up to +100°C) FKM, polyamide coil PTFE/graphite, epoxy coil: 0 to +180°C
<b>Ambient temperature</b>	-10 to +55°C
<b>Viscosity</b>	max. 21 mm <sup>2</sup> /s
<b>Operating voltage</b>	24 V DC, 24 V/50 Hz, 230 V/50 Hz (other voltages on request)
<b>Voltage tolerance</b>	±10%
<b>Duty cycle/single valve</b>	100% continuous rating Intermittent operation 60% (30 min) or with 5 W coil (on request)
<b>Electrical connection</b>	according to DIN EN 175301-803 Form A for cable plug Type 2508 (see Ordering chart for Accessories)
<b>Protection class</b>	IP65 with cable plug
<b>Installation</b>	As required, preferably with actuator in upright position

## Technical data, continued

## Power consumption

Coil size [mm]	Voltage AC Power consumption			Coil insulation class	Voltage DC Power consumption		Coil insulation class
	Inrush [VA]	Hold (hot coil) [VA]	[W]		(hot / cold coil) [W]		
<b>Power consumption for circuit function A (NC)</b>							
32	24	17	8	B	10 / 12 7 (impulse version)		H
40	30	22	10	B	12 / 13.5		H
<b>Power consumption for circuit function B (NO)</b>							
32	24	16	7	B	8 / 9.5		H

## Response times

Response times	
AC and DC Opening [ms]	Closing [ms]
20	30

## Response times [ms]:

Measured at valve outlet at 6 bar and +20 °C

Opening: pressure build-up 0 to 90%,  
closing: pressure relief 100 to 10%

## Programme overview of the 6027 Series

## The 6027 Series

## Mini

AC07 coil

20 mm



G 1/8  
2/2, 3/2-way

## Small

AC10 coil

32/40 mm



G 1/8 - G 3/8, sub-base  
2/2, 3/2-way

## Compact

AC19 coil

42 mm



G 1/4 - G 1/2  
2/2-way

## More info.

For more technical information about this product, click on this box... you will come to our website for this product where you can download the datasheet.

The 6027 series consists of three construction sizes:

**Mini** AC07 coil (20 mm), **Small** AC10 coil (32 and 40 mm) and **Compact** AC19 coil (42 mm).

The modules can be combined to allow all variations of functions, temperature ranges, coil ratings, seal- and body materials. The idea behind the programme is to simplify selection, minimise components by means of standardisation and allow virtually unlimited combinations of options.

For further information about the different construction sizes please see individual datasheets

6027\_mini\_2/2 & 3/2-way

6027\_small\_2/2 & 3/2-way

6027\_compact\_2/2-way

## Ordering chart for valves, standard temperature version for DC power supply

Voltage/frequency 024/DC, valves with AC10 coil (32 or 40 mm), seal material FKM, without cable plug

Circuit function	Port connection	Orifice [mm]	Kv value water [m <sup>3</sup> /h] <sup>1)</sup>	Pressure range [bar] <sup>2)</sup> /DC	Power consumption DC (hot / cold coil) [W]	Coil size	Voltage/frequency DC Item no. 024/DC		
<b>A</b> 2/2-way valve, NC 	<b>Coil insulation class H (epoxy coil), media temperature -10 up to +120°C</b>								
	<b>Brass body</b>								
	Threaded port 	G 1/8	2.0	0.15	0-20	10 / 12	32 mm	177 574	
			2.5	0.2	0-10	10 / 12	32 mm	177 577	
			3.0	0.3	0-6	10 / 12	32 mm	177 580	
		G 1/4	2.0	0.15	0-20	10 / 12	32 mm	177 583	
			2.5	0.2	0-10	10 / 12	32 mm	177 586	
			3.0	0.3	0-6	10 / 12	32 mm	177 589	
		or sub-base 32 mm 	G 1/4	4.0	0.4	0-6	12 / 13.5	40 mm	177 592
				5.0	0.5	0-2.5	12 / 13.5	40 mm	184 605
				6.0	0.6	0-1	12 / 13.5	40 mm	177 595
		G 3/8	3.0	0.3	0-6	10 / 12	32 mm	177 598	
			4.0	0.4	0-6	12 / 13.5	40 mm	177 601	
			6.0	0.6	0-1	12 / 13.5	40 mm	177 604	
	sub-base	G 3/8	2.0	0.15	0-20	10 / 12	32 mm	177 692	
			2.5	0.2	0-10	10 / 12	32 mm	177 695	
			3.0	0.3	0-6	10 / 12	32 mm	177 698	
	<b>Stainless steel body</b>								
	Threaded port 	G 1/8	2.0	0.15	0-20	10 / 12	32 mm	177 607	
			2.5	0.2	0-10	10 / 12	32 mm	177 701	
		G 1/4	2.0	0.15	0-20	10 / 12	32 mm	177 613	
			3.0	0.3	0-6	10 / 12	32 mm	177 703	
		G 1/4	4.0	0.4	0-6	12 / 13.5	40 mm	177 616	
			<b>Brass body (stainless steel body on request)</b>						
Threaded port 		G 1/8	2.0	0.15	0-14	8 / 9.5	32 mm	177 521	
			2.5	0.2	0-10	8 / 9.5	32 mm	177 524	
	3.0		0.3	0-7	8 / 9.5	32 mm	177 527		
	G 1/4	2.0	0.15	0-14	8 / 9.5	32 mm	177 530		
		2.5	0.2	0-10	8 / 9.5	32 mm	177 533		
		3.0	0.3	0-7	8 / 9.5	32 mm	177 536		
	G 1/4	6.0	0.6	0-1.5	8 / 9.5	32 mm	177 539		
		G 3/8	3.0	0.3	0-7	8 / 9.5	32 mm	177 542	
			6.0	0.6	0-1.5	8 / 9.5	32 mm	177 545	

<sup>1)</sup> Measured at +20 °C, 1 bar<sup>2)</sup> pressure at valve inlet and free outlet.<sup>2)</sup> Overpressure with respect to atmospheric pressure**Please note** that the cable plug has to be ordered separately, see Accessories on page 8 and separate datasheet for Type 2508.**i Further versions on request****Materials**

Seal material EPDM for -30 to +120°C, FDA, KTW

**Port connection**

NPT, Rc

**Voltage**

Non-standard voltages

**Approvals**







ATEX, UL, CSA, FM-Ex Div. I

**Additional**

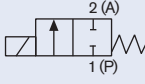
Oil and fat-free (oxygen version)

## Ordering chart for valves, standard temperature version for AC power supply

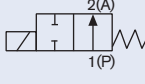
Voltage/frequency 024/50 and 230/50, valves with AC10 coil (32 or 40 mm), seal material FKM, without cable plug

Circuit function	Port connection	Orifice [mm]	Kv value water [m <sup>3</sup> /h] <sup>1)</sup>	Pressure range [bar] <sup>2)</sup> AC	Power consumption hold AC (hot coil) [W]	Coil size	Voltage / frequency AC			
							Item no. 024/50	Item no. 230/50		
<b>A</b> 2/2-way valve, NC 	<b>Coil insulation class B (polyamide coil), media temperature -10 up to 100°C</b>									
	<b>Brass body</b>									
	Threaded port 32/40 mm 	G 1/8	2.0	0.15	0-25	8	32 mm	177 575	177 576	
			2.5	0.2	0-16	8	32 mm	177 578	177 579	
			3.0	0.3	0-10	8	32 mm	177 581	177 582	
		G 1/4	2.0	0.15	0-25	8	32 mm	177 584	177 585	
			2.5	0.2	0-16	8	32 mm	177 587	177 588	
			3.0	0.3	0-10	8	32 mm	177 590	177 591	
		4.0	0.4	0-6	10	40 mm	177 593	177 594		
			5.0	0.5	0-4	10	40 mm	184 606	184 607	
			6.0	0.6	0-2.5	10	40 mm	177 596	177 597	
		or sub-base 32 mm 	G 3/8	3.0	0.3	0-10	8	32 mm	177 599	177 600
				4.0	0.4	0-6	10	40 mm	177 602	177 603
				6.0	0.6	0-2.5	10	40 mm	177 605	177 606
	sub-base		2.0	0.15	0-25	8	32 mm	177 693	177 694	
			2.5	0.2	0-16	8	32 mm	177 696	177 697	
			3.0	0.3	0-10	8	32 mm	177 699	177 700	
	<b>Stainless steel body</b>									
	Threaded port 32/40 mm 	G 1/8	2.0	0.15	0-25	8	32 mm	177 608	177 609	
			2.5	0.2	0-16	8	32 mm	177 610	177 611	
		G 1/4	2.0	0.15	0-25	8	32 mm	177 612	177 702	
			3.0	0.3	0-10	8	32 mm	177 614	177 615	
			4.0	0.4	0-6	10	40 mm	177 617	177 618	
<b>B</b> 2/2-way valve, NO 	<b>Coil insulation class H (epoxy coil), media temperature -10 up to +100°C</b>									
	<b>Brass body (stainless steel body on request)</b>									
	Threaded port 32 mm 	G 1/8	2.0	0.15	0-14	7	32 mm	177 522	177 523	
			2.5	0.2	0-10	7	32 mm	177 525	177 526	
			3.0	0.3	0-7	7	32 mm	177 528	177 529	
		G 1/4	2.0	0.15	0-14	7	32 mm	177 531	177 532	
			2.5	0.2	0-10	7	32 mm	177 534	177 535	
			3.0	0.3	0-7	7	32 mm	177 537	177 538	
		6.0	0.6	0-1.5	7	32 mm	177 540	177 541		
			G 3/8	3.0	0.3	0-7	7	32 mm	177 543	177 544
				6.0	0.6	0-1.5	7	32 mm	177 546	177 547

<sup>1)</sup> Measured at +20 °C, 1 bar<sup>2)</sup> pressure at valve inlet and free outlet.<sup>2)</sup> Overpressure with respect to atmospheric pressure**Please note** that the cable plug has to be ordered separately, see Accessories on page 8 and separate datasheet for Type 2508.**i Further versions on request****Materials**

Seal material EPDM for -30 to +120°C, FDA, KTW

**Port connection**

NPT, Rc

**Voltage**

Non-standard voltages

**Approvals**

ATEX, UL, CSA, FM-Ex Div. I

**Additional**

Oil and fat-free (oxygen version)

Ordering chart for valves, standard temperature version for DC power supply, impulse version

Voltage/frequency 024/DC, valves with AC10 coil (32 mm), impulse version, seal material FKM, without cable plug

Circuit function	Port connection	Orifice [mm]	Kv value water [m <sup>3</sup> /h] <sup>1)</sup>	Pressure range [bar] <sup>2)</sup> DC	Power consumption DC (hot / cold coil) [W]	Voltage/frequency DC		
						Item no. 006/DC	Item no. 024/DC	
<b>A</b> 2/2-way valve, NC 	<b>Impulse version, coil insulation class H (epoxy coil), media temperature -10 up to +120°C</b>							
	<b>Brass body</b>							
	Threaded port 32 mm 	G 1/4	3.0	0.3	0-6	7	184 590	184 591
			4.0	0.4	0-1.5	7	184 593	184 594
			6.0	0.6	0-0.5	7	184 595	184 596
	or sub-base 32 mm 	sub-base	2.0	0.15	0-16	7	182 020	183 928
			2.5	0.2	0-10	7	184 597	182 017
3.0			0.3	0-6	7	184 598	184 599	

<sup>1)</sup> Measured at +20 °C, 1 bar<sup>2)</sup> pressure at valve inlet and free outlet.

<sup>2)</sup> Overpressure with respect to atmospheric pressure

**Please note** that the cable plug has to be ordered separately, see Accessories on page 8 and separate datasheet for Type 2508.

Activation of the impulse version with inverse polarity operation



Polarity (labeled on the valve)	Description	Terminal connections
- switch ON +	Valve (P-seat) will be opened	(+) on terminal 2 and (-) on terminal 1 (see below)
+ switch OFF -	Valve (P-seat) will be closed	(+) on terminal 1 and (-) on terminal 2 (see below)

Impulse duration min. 50 ms.

**Important:** Only cable plug without circuitry should be used together with impulse version!

Ordering chart for valves, high temperature version for DC and AC power supply

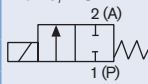
Valves with AC10 coil (32 mm), seal material PTFE/graphite, without cable plug



Circuit function	Port connection	Orifice [mm]	Kv value water [m <sup>3</sup> /h] <sup>1)</sup>	Pressure range [bar] <sup>2)</sup>		Power consumption		Coil size	Item no. per voltage/frequency [V/Hz]			
				AC	DC	hot AC [W]	DC (hot / cold coil) [W]		024/DC	024/50	230/50	
<b>A</b> 2/2-way valve, NC  	<b>Coil insulation class H (epoxy coil), media temperature up to +180°C</b>											
	<b>Stainless steel body</b>											
	Threaded	G 1/8	3.0	0.3	0-10	0-5	8	10 / 12	32 mm	177 619	177 620	177 621
	port	G 1/4	3.0	0.3	0-10	0-5	8	10 / 12	32 mm	177 622	177 623	177 624
					0-12	0-7	10	12 / 13.5	40 mm	177 625	177 626	177 627
		4.0	0.4	0-6	0-4	10	12 / 13.5	40 mm	184 601	184 602	184 603	

<sup>1)</sup> Measured at +20 °C, 1 bar<sup>2)</sup> pressure at valve inlet and free outlet.

<sup>2)</sup> Overpressure with respect to atmospheric pressure

**Please note** that the cable plug has to be ordered separately, see Accessories on page 8 and separate datasheet for Type 2508.

**i Further versions on request**

-  **Port connection**  
NPT, Rc
-  **Voltage**  
Non-standard voltages
-  **Approvals**  
UL, UR, CSA, ATEX

**Materials**

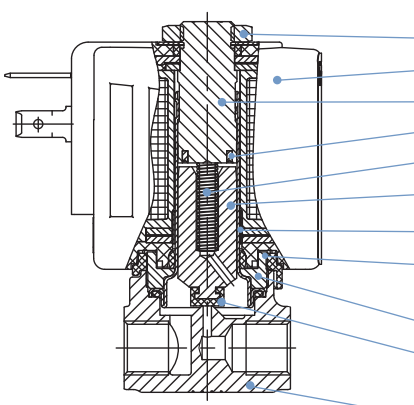
	<b>Locknut</b>	DIN 176 9Sn Pb 28K thick-film-passivated or stainless steel
	<b>Coil</b>	Epoxy and polyamide
	<b>Stopper</b>	Stainless steel 1.4113
	<b>Shading ring</b>	Copper (brass body), silver (stainless steel body)
	<b>Spring</b>	Stainless steel 1.4310
	<b>Plunger</b>	Stainless steel 1.4113
	<b>Guide tube</b>	Stainless steel 1.4303
	<b>Seal</b>	FKM, graphite for high temperature versions (EPDM on request)
	<b>Nipple</b>	Brass, stainless steel 1.4305
	<b>Seat seal</b>	FKM, PTFE for high temperature versions (EPDM on request)
	<b>Body</b>	Brass, stainless steel 316L (1.4404)

Drawing shows threaded port version

Dimensions [mm] and weight [g]

Threaded port

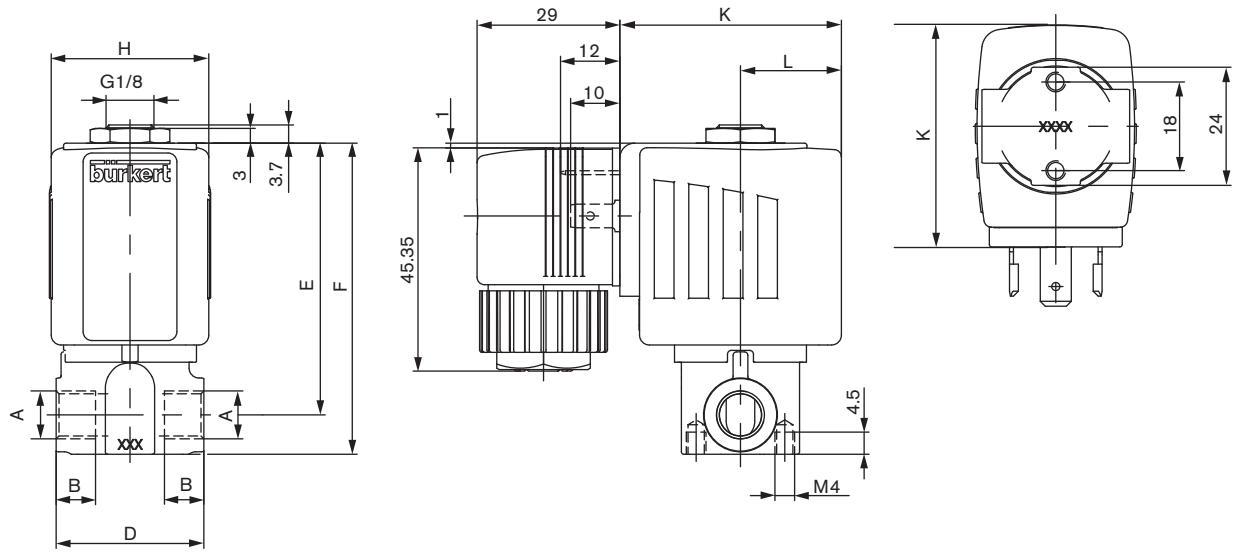

Sub-base

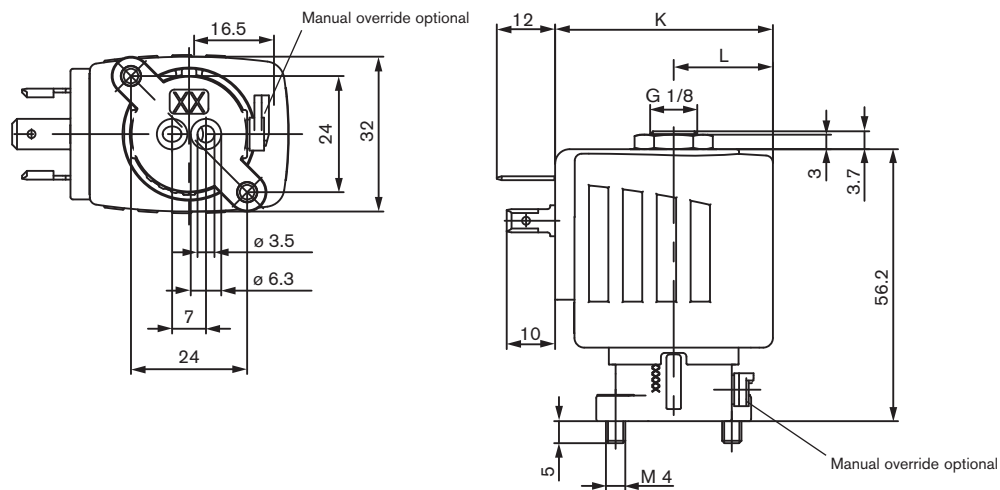

A port connection	B [mm]	D [mm]	E [mm]	F [mm]	H coil width [mm]	K coil depth [mm]	L [mm]	Weight	
								Epoxy coil [g]	Polyamide coil [g]
<b>Threaded port</b>									
G 1/8	8	30	55.2	63.2	32	45	20.5	260	240
G 1/4	12	40	57.2	67.2	40	51	23.5	380	340
					32	45	20.5	300	280
G 3/8	12	50	58.2	70.2	40	51	23.5	410	370
					32	45	20.5	330	310
<b>Sub-base</b>									
Sub-base	see drawing above				32	45	20.5	240	220

## Ordering chart for accessories

## Cable plug Type 2508 according to DIN EN 175301-803 Form A

	Circuitry	Voltage / frequency	Item no.
	None (standard)	0 - 250 V AC/DC	008 376
	with LED	12 - 24 V AC/DC	008 360
	with LED and varistor	12 - 24 V AC/DC	008 367
	with rectifier, LED and varistor	12 - 24 V AC/DC	008 363
	with LED	200 - 240 V	008 362
	with LED and varistor	200 - 240 V	008 369
	further versions see datasheet Type 2508		

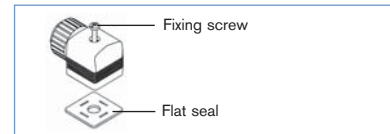

The delivery of a cable plug includes the flat seal and the fixing screw. For other cable plug versions acc. to DIN EN 175301-803 Form A (previously DIN 43650), see separate datasheet Type 2508. Click on the box "More info."... you will come to our website for this product where you can download the datasheet.

**More info.**

## Manifold mounting

Accessory part	Features				Item no.
Single manifold	from aluminium anodized				005 020
Multiple manifold	from aluminium	<b>Hole spacing A [mm]</b>	<b>Total length B [mm]</b>	<b>Hole spacing C [mm]</b>	
	for 2 valves	57	65	–	005 023
	for 3 valves	90	98	–	005 286
	for 4 valves	123	131	–	005 287
	for 5 valves	156	164	57	005 035
	for 6 valves	189	197	57	005 038
	for 8 valves	255	263	90	005 386
	for 10 valves	321	329	90	005 764
Covering plate	with plugs and O-ring, for closing off unused valve positions				005 630

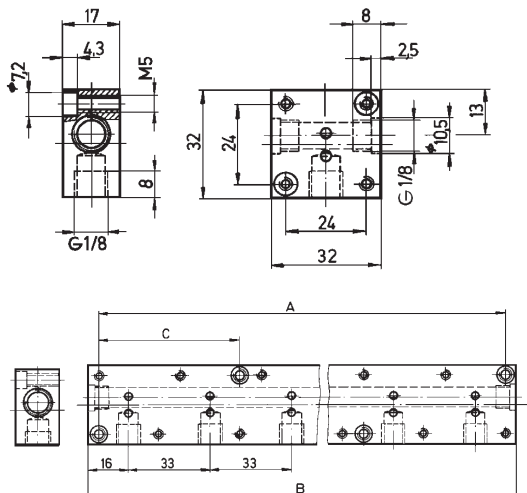

## Manifold mounting

With manifold mounting, please comply with the permissible duty cycle (5 W models with 100% continuous rating or 8 W model with 60% duty cycle/20 min.). The pressure port for the manifold is designated with P (R), and the outlet port with A (B). Only connect together ports with the same designation.

2/2-way valves of Type 6027 can be operated together on a manifold with Type 6027 3/2-way valves circuit function C (not D!) if the operating pressures agree according to the rating plates. The manifolds can also be expanded if the valve functions are taken into consideration.

**Caution!** Unused, open valve ports must be closed off with covering plates (see Ordering chart above).

To find your nearest Bürkert facility, click on the orange box → [www.burkert.com](http://www.burkert.com)

In case of special application conditions, please consult for advice.

Subject to alteration.  
© Christian Bürkert GmbH & Co. KG

0908/5\_EU-en\_00895013