

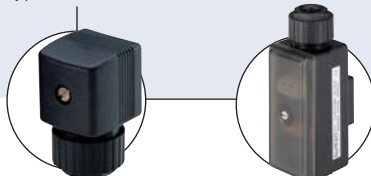

3/2-way Small Solenoid Valve, G 1/8 - G 1/4 and sub-base

- Direct-acting, normally closed and normally open
- Brass and stainless steel body
- Electrical connection cable plug Form A
- With or without manual override as standard
- Also available as impulse version

Type 6027 Small can be combined with...



Type 2508
Cable plug

Type 1078
Timer unit

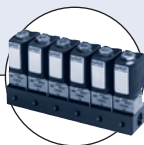

Type 6027
Multiple manifold
(e.g. 6-fold)



Type 2511
ASI cable plug

Type 6027 is a direct-acting solenoid valve used for shut-off, dosing, filling, ventilating and for vacuum. The push-over solenoid system is of modular design and may be mounted individually or as a block on a multiple manifold. The coil can be rotated 360°.

For use as impulse version please see instructions on p. 4.

Circuit function C

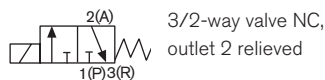

Circuit function D

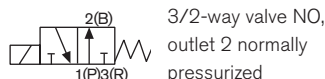

Technical data	
Port connection	G 1/8, G 1/4, sub-base
Orifice	DN 1.5 - 3.0
Body materials	Brass or stainless steel 1.4404 (316L)
Coil materials	Polyamide and epoxy
Coil insulation class	Polyamide class B, epoxy class H
Seal material	FKM (EPDM on request)
Media	Vacuum, neutral gases and fluids (e.g. compressed air, water, hydraulic oil) and slightly aggressive media (stainless steel version)
Media temperature	Polyamide coil (FKM seal) -10 to +100°C Epoxy coil (FKM seal) -10 to +120°C
Ambient temperature	-10 to +55°C
Viscosity	max. 21 mm ² /s
Operating voltage	24 V DC, 24 V/50 Hz, 230 V/50 Hz (other voltages on request)
Voltage tolerance	±10%
Duty cycle/single valve	100% continuous rating Intermittent operation 60% (30 min) or with 5 W coil (on request)
Electrical connection	according to DIN EN 175301-803 Form A for cable plug Type 2508 (see Ordering chart for Accessories)
Protection class	IP65 with cable plug
Installation	As required, preferably with actuator in upright position

Technical data, continued

Power consumption

Orifice [mm]	Power consumption			DC (hot / cold coil) [W]
	Inrush AC [VA]	Hold AC (hot coil) [VA]	[W]	
1.5-3.0	24	17	8	8 / 9.5 7 (impulse version)

Response times

Orifice [mm]	Response times AC and DC	
	Opening [ms]	Closing [ms]
1.5	10-15	15-20
2.0	10-15	15-20
2.8	15-20	10-22
3.0	15-20	10-22

Response times [ms]:

Measured at valve outlet at 6 bar and +20 °C

Opening: pressure build-up 0 to 90%, closing: pressure relief 100 to 10%

Programme overview of the 6027 Series

The 6027 Series

Mini

AC07 coil

20 mm

G 1/8
2/2, 3/2-way

Small

AC10 coil

32/40 mm

G 1/8 - G 3/8, sub-base
2/2, 3/2-way

Compact

AC19 coil

42 mm

G 1/4 - G 1/2
2/2-way

More info.

For more technical information about this product, click on this box... you will come to our website for this product where you can download the datasheet.

The 6027 series consists of three construction sizes:

Mini AC07 coil (20 mm), **Small** AC10 coil (32 and 40 mm) and **Compact** AC19 coil (42 mm).

The modules can be combined to allow all variations of functions, temperature ranges, coil ratings, seal- and body materials. The idea behind the programme is to simplify selection, minimise components by means of standardisation and allow virtually unlimited combinations of options.

For further information about the different construction sizes please see individual datasheets







6027_mini_2/2 & 3/2-way

6027_small_2/2 & 3/2-way

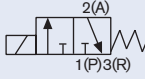
6027_compact_2/2-way

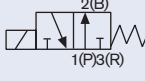
Ordering chart for valves (further versions on request)

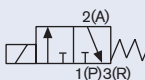
All valves with AC10 coil (32 mm), seal material FKM, coil insulation class B (polyamide coil), media temperature -10° to +100°C, without cable plug

Circuit function	Port connection	Orifice [mm]	Kv value water [m ³ /h] ¹⁾	Pressure range [bar] ²⁾	Power consumption		Item no. per voltage/frequency [V/Hz]				
					hold AC (hot coil) [W]	DC (hot / cold coil) [W]	024/DC	024/50	230/50		
Without manual override											
C 3/2-way valve NC, outlet 2 relieved 	Threaded port  or sub-base 	Brass body									
		G 1/8	1.5	0.07	0-16	8	8 / 9.5	177 633	177 634	177 635	
			2.0	0.11	0-10	8	8 / 9.5	177 636	177 637	177 638	
		G 1/4	2.0	0.11	0-10	8	8 / 9.5	177 639	177 640	177 641	
			3.0	0.2	0-6	8	8 / 9.5	177 642	177 643	177 644	
		Sub-base	2.0	0.11	0-10	8	8 / 9.5	177 674	177 675	177 676	
	Stainless steel body										
	D 3/2-way valve, NO, outlet 2 normally pressurized 	Threaded port 	Brass body								
			G 1/8	1.5	0.07	0-16	8	8 / 9.5	177 646	177 647	177 648
				2.0	0.11	0-10	8	8 / 9.5	177 649	177 650	177 651
			G 1/4	2.0	0.11	0-10	8	8 / 9.5	177 652	177 653	177 654
				2.8	0.2	0-6	8	8 / 9.5	177 656	177 657	177 658
Stainless steel body											
C 3/2-way valve NC, outlet 2 relieved 	Threaded port 	Brass body									
		G 1/8	2.0	0.11	0-10	8	8 / 9.5	177 680	177 681	177 682	
			3.0	0.2	0-6	8	8 / 9.5	177 683	177 684	177 685	
		G 1/4	2.0	0.11	0-10	8	8 / 9.5	177 686	177 687	177 688	
3.0	0.2		0-6	8	8 / 9.5	177 689	177 690	177 691			

¹⁾ Measured at +20 °C, 1 bar²⁾ pressure at valve inlet and free outlet.

²⁾ Overpressure with respect to atmospheric pressure

Please note that the cable plug has to be ordered separately, see Accessories on page 7 and separate datasheet for Type 2508.

i Further versions on request



Materials

Epoxy coil according to Form A
Seal material EPDM



Voltage

Non-standard voltages



Port connection

Sub-base version with manual override (brass or stainless steel);
NPT, Rc thread



Approvals

ATEX, UL, UR, CSA, FM-Ex Div. I





Additional

Oxygen versions

Ordering chart for valves, impulse version (further versions on request)

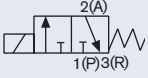
All valves with AC10 coil (32 mm), impulse version, seal material FKM, coil insulation class H (epoxy coil), media temperature -10° to +120°C, without manual override and cable plug

Circuit function	Port connection	Orifice [mm]	Kv value water [m ³ /h] ¹⁾	Pressure range [bar] ²⁾	Power consumption DC (hot / cold coil) [W]	Item no. per voltage/frequency [V/Hz]			
						006/DC	012/DC	024/DC	
C 3/2-way valve NC, outlet 2 relieved 	Threaded port 32 mm  or sub-base 32 mm 	Brass body							
		G 1/8	1.5	0.07	0-16	7	184 640	183 936	184 641
			2.0	0.11	0-10	7	183 803	183 802	184 642
		Sub-base	2.0	0.11	0-10	7	182 019	182 768	184 643

¹⁾ Measured at +20 °C, 1 bar²⁾ pressure at valve inlet and free outlet.

²⁾ Overpressure with respect to atmospheric pressure

Please note that the cable plug has to be ordered separately, see Accessories on page 7 and separate datasheet for Type 2508.

Activation of the impulse version with inverse polarity operation

Polarity (labeled on the valve)	Description	Terminal connections
- switch ON +	Valve (P-seat) will be opened	(+) on terminal 2 and (-) on terminal 1 (see below)
+ switch OFF -	Valve (P-seat) will be closed	(+) on terminal 1 and (-) on terminal 2 (see below)

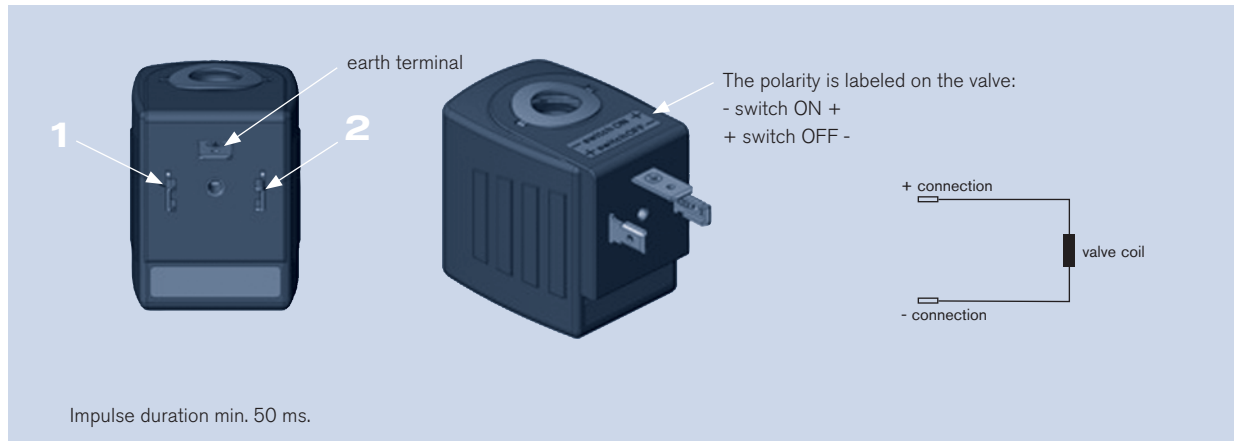

Important: Only cable plug without circuitry should be used together with impulse version!

Materials

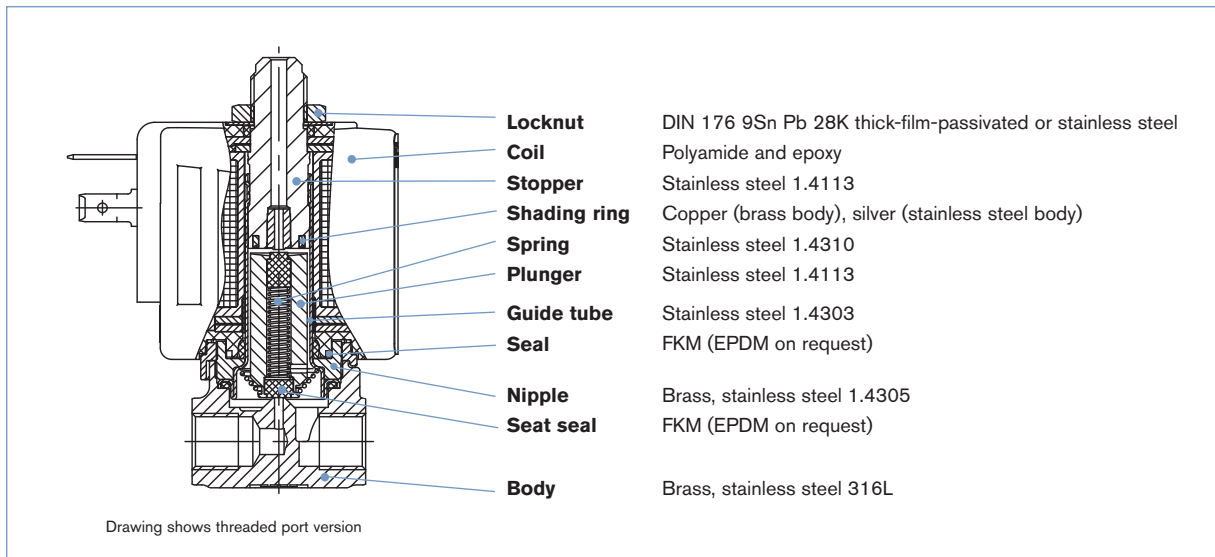

Dimensions [mm] and weight [g]

Threaded port

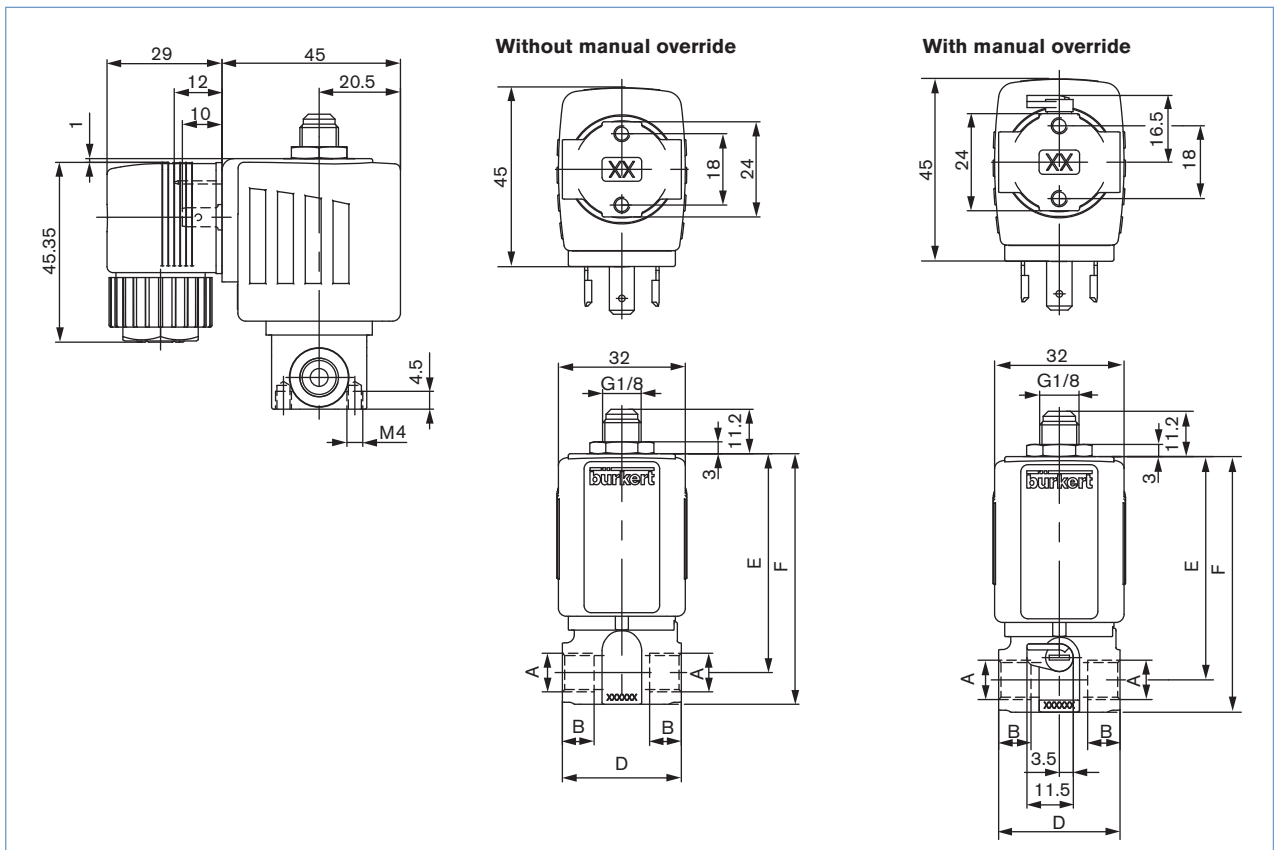

A port connection	B [mm]	D [mm]	E [mm]	F [mm]	Weight threaded port	
					Polyamide coil [g]	Epoxy coil (on request) [g]
G 1/8	8	30	55.2	63.2	240	260
G 1/4	12	40	57.2	67.2	280	300

Dimensions [mm] and weight [g], continued

Sub-base

Weight sub-base	
Polyamide coil [g]	Epoxy coil (on request) [g]
220	240

Port connection chart

The ports marked with I, II and III are marked as in the configuration table, depending on the circuit function

Possible port configurations				
Circuit function / Port	I	II	III	
C	1(P)	3(R)	2(A)	
D	3(R)	1(P)	2(B)	

Ordering chart for accessory

Cable plug Type 2508 according to DIN EN 175301-803 Form A

	Circuitry	Voltage / frequency	Item no.
	None (standard)	0 - 250 V AC/DC	008 376
	with LED	12 - 24 V AC/DC	008 360
	with LED and varistor	12 - 24 V AC/DC	008 367
	with rectifier, LED and varistor	12 - 24 V AC/DC	008 363
	with LED	200 - 240 V	008 362
	with LED and varistor	200 - 240 V	008 369
	further versions see datasheet Type 2508		

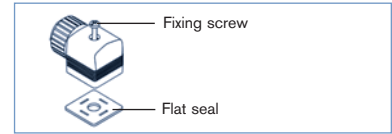

The delivery of a cable plug includes the flat seal and the fixing screw. For other cable plug versions acc. to DIN EN 175301-803 Form A (previously DIN 43650), see separate datasheet Type 2508. Click on the box "More info."... you will come to our website for this product where you can download the datasheet.



Ordering chart for manifold mounting

Accessory part	Features				Item no.
Single manifold	from aluminium				005 020
Multiple manifold	from aluminium	Hole spacing A [mm]	Total length B [mm]	Hole spacing C [mm]	
	2 valves	57	65	-	005 023
	3 valves	90	98	-	005 286
	4 valves	123	131	-	005 287
	5 valves	156	164	57	005 035
	6 valves	189	197	57	005 038
	8 valves	255	263	90	005 386
	10 valves	321	329	90	005 764
Covering plate	with plugs and O-ring, for closing off unused valve positions				005 630

Manifold mounting

With manifold mounting, please comply with the permissible duty cycle (5 W models with 100% continuous rating or 8 W model with 60% duty cycle). The pressure port for the manifold is designated with P (R), and the outlet port with A (B). Only connect together ports with the same designation.

2/2-way valves of Type 6027 can be operated together on a manifold with Type 6027 3/2-way valves circuit function C (not D) if the operating pressures agree according to the rating plates. The manifolds can also be expanded if the valve functions are taken into consideration.

Caution! Unused, open valve ports must be closed off with covering plates (see Ordering chart above).

To find your nearest Bürkert facility, click on the orange box → www.burkert.com